

## Dual color 2216 LED strip 240LEDs/M DC24V

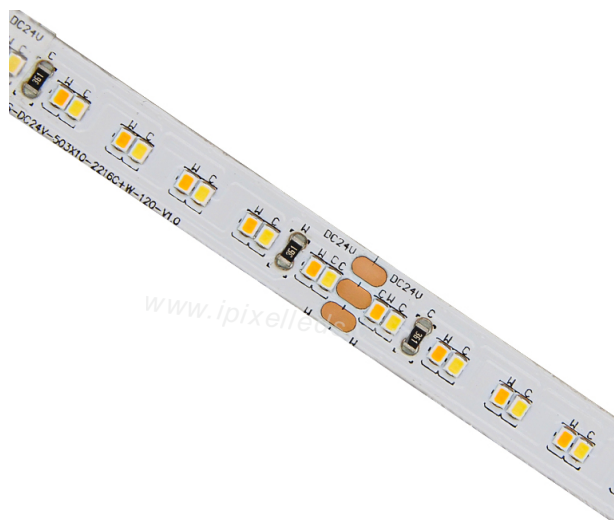

### ◆ Product Description:

- High density CCT color Adjustable LED strip has 240pcs 2216 LEDs
- With 10mm Width
- Cut-able every 12LEDs & 50mm
- All soldering Pads are very large, allowing you to easily cut and reconnect
- DC24V constant voltage operation
- Both ends have 3pin bare wires for powering
- 3M tape attached on backside of FPC



### ◆ Product Datasheet

Product Number	S010240XC2PZ
Operating Voltage	DC24V
Power/m	20W
SMD Type	2216
LED Qty/m	120+120
Cutting Length	50mm/12LED
Color	3000K+6500K
Luminance/m	CW: 832 WW:782lm
Material	FPC
Control	PWM
Beam Angle	120°
Size (mm)	5000x10mm
IP Rating	IP20/IP65
Operation Temperature	- 25 ~ 60°C

#### Remarks:

- 1.The above parameters were tested according to integrating sphere TM-30-15.
- 2.The output data is based on IP20 and one merter.
- 3.The data such as power etc, ±15% tolerance is normal.
- 4.IP protection process causes changes in size, CCT and luminous flux.

## ◆ Outline Dimension (unit: mm/in)

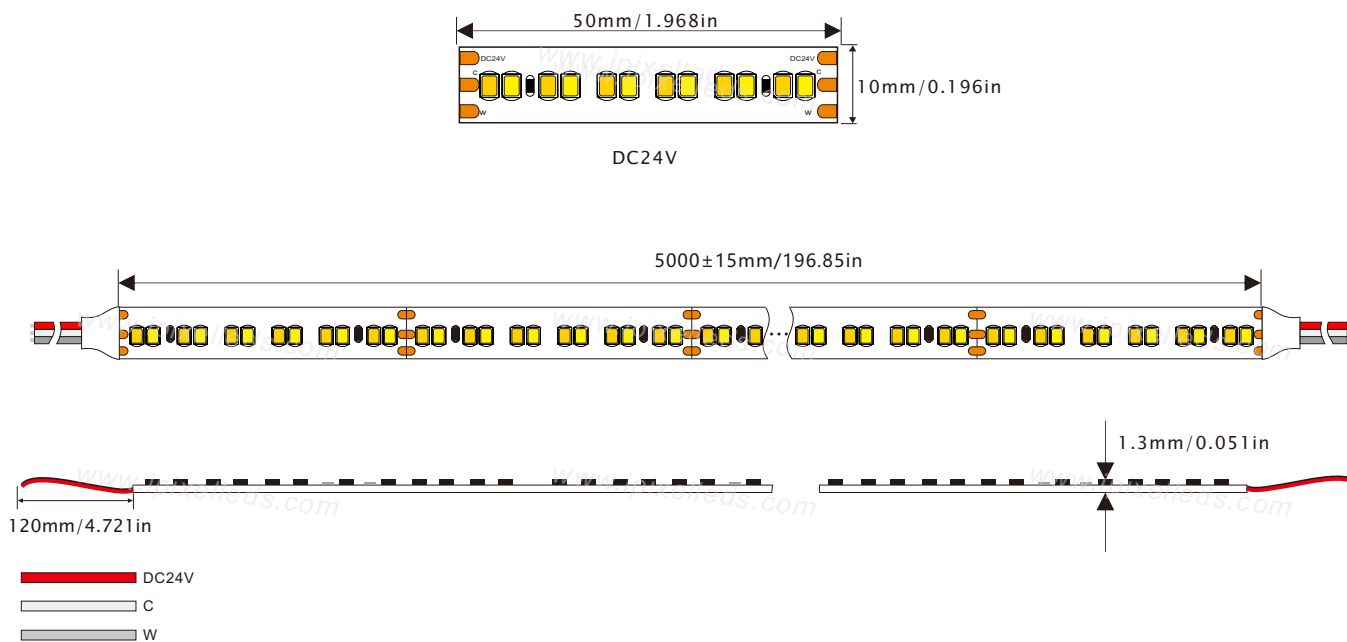

## ◆ Wiring diagram

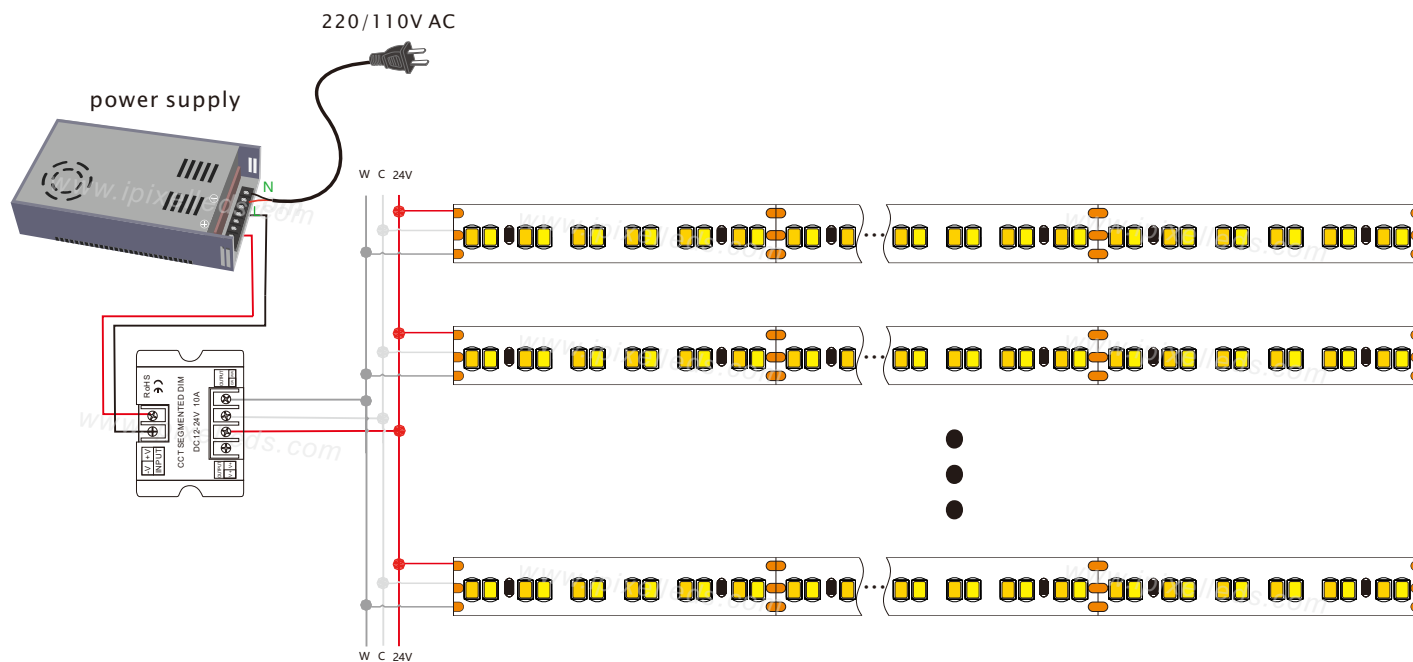

## ◆ IP Rating



### ◆ Related products:



Power supply  
LRS-350-24

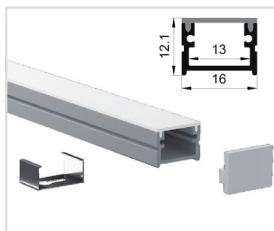

Alum profile  
1613



Dual Color LED Controller  
V2+R7-1

### ◆ Installation method:

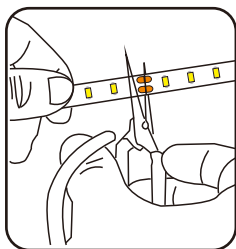

Can be cut

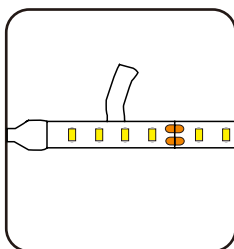

Tear off the 3M adhesive as need

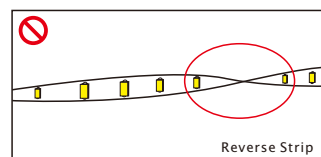
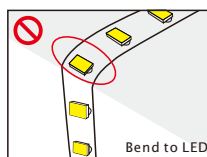
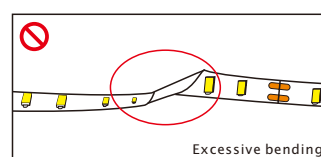
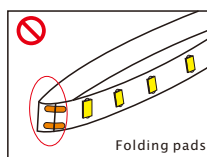

Distortion(Wrong)

### ◆ Product packaging



Reel

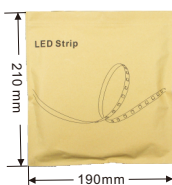

Antistatic bag

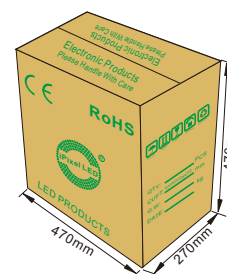

Note: The parameters are subject to change without notice!

A1.25-03-04