

2 wires Dual Color 2835 LED strip 240LEDs/M DC24V



◆ Product Description:

- High density CCT color Adjustable LED strip has 240pcs 2835 LEDs
- With 10mm Width, 2 Ounce copper
- Cut-able every 12LEDs & 50mm
- All soldering Pads are very large, allowing you to easily cut and reconnect
- DC24V constant voltage operation
- Both ends have 3pin bare wires for powering
- 3M tape attached on backside of FPC



◆ Product Datasheet

Product Number	S010240BC2PZ(2W)
Operating Voltage	DC24V
Power/m	10W
SMD Type	SMD 2835
LED Qty/m	120+120
Cutting Length	50mm / 12LED
Color	2800-3200K+6000-6500K
Luminance/m	CW:1155 WW:1096lm
Material	FPC
Control	PWM
Beam Angle	120°
Size (mm)	5000x10mm
IP Rating	IP20/IP65
Operation Temperature	- 25 ~ 60°C

Remarks:

- 1.The above parameters were tested according to integrating sphere TM-30-15.
- 2.The output data is based on IP20 and one merter.
- 3.The data such as power etc, $\pm 15\%$ tolerance is normal.
- 4.IP protection process causes changes in size, CCT and luminous flux.

Outline Dimension (unit:mm/in)

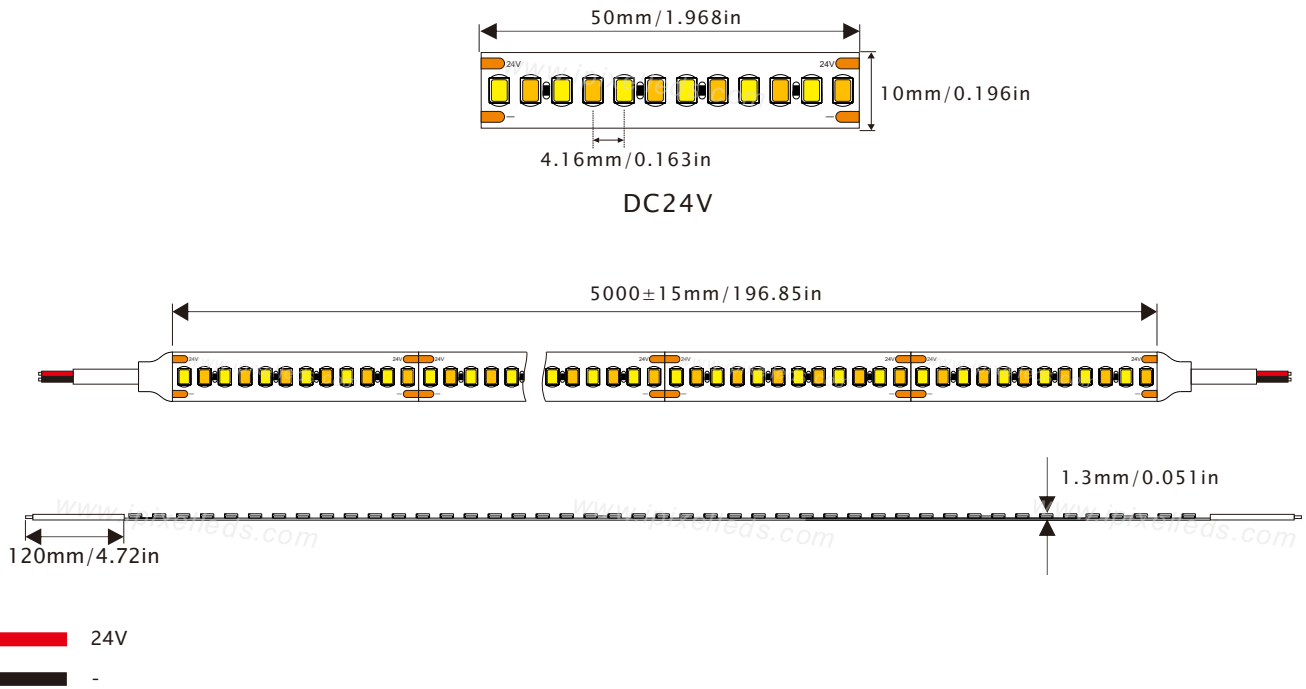

Wiring diagram

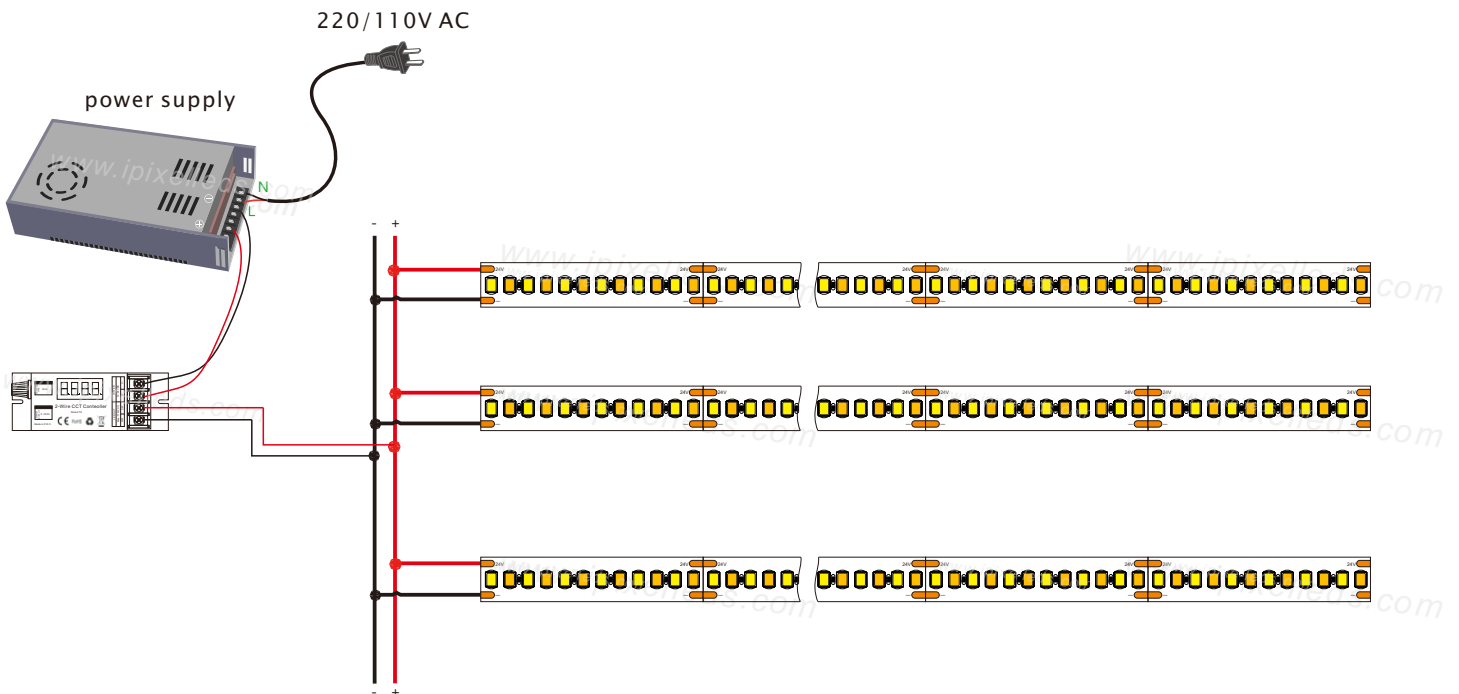

IP Rating



◆ Related products:



Power supply
LRS-350-24

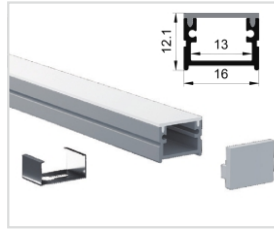

Alum profile
1613



2 wires CCT Controller
HX-T7+RW42

◆ Installation method:

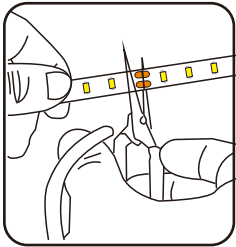

Can be cut

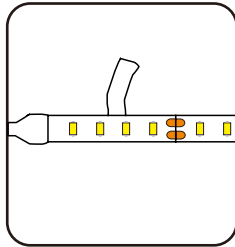

Tear off the 3M adhesive as need

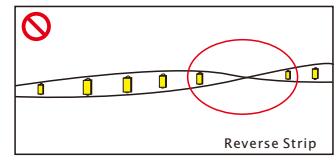
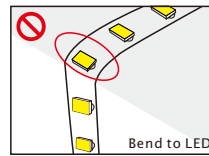
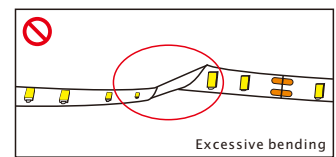
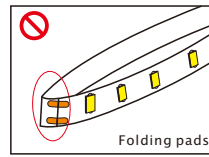

Distortion(Wrong)

◆ Product packaging



Reel

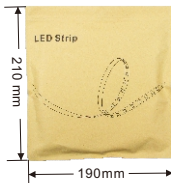

Antistatic bag

