

# SMD 4040 RGB LED Strip 120LEDs/M DC12V/24V



## ◆ Product Description:

- This is a PWM control RGB color LED strip without Pixel
- 120pcs SMD 4040 RGB LED per meter
- 5meters/reel, 8mm PCB width
- DC12/24V constant voltage operation
- Both ends have 4pin bare wires for powering
- 3M tape attached on backside of FPC



## ◆ Product Datasheet

Product Number	S008120TB3PZ	S008120TC3PZ
Operating Voltage	DC12V	DC24V
Power/m	27W	27W
SMD Type	SMD 4040	SMD 4040
LED Qty/m	120	120
Cutting Length	25mm/3LED	50mm/6LED
Color	R G B	R G B
Luminance/m	R:227 G:625 B:150lm	R:223 G:618 B:154lm
Wavelength	R:620-625 G:520-525 B:460-465nm	R:620-625 G:520-525 B:460-465nm
Material	FPC	FPC
Control	PWM	PWM
Beam Angle	120°	120°
Size (mm)	5000x8mm	5000x8mm
IP Rating	IP20/IP64/IP65/IP67	IP20/IP64/IP65/IP67
Operation Temperature	- 25 ~ 60°C	- 25 ~ 60°C

### Remarks:

- 1.The above parameters were tested according to integrating sphere TM-30-15.
- 2.The output data is based on IP20 and one merter.
- 3.The data such as power etc,  $\pm 15\%$  tolerance is normal.
- 4.IP protection process causes changes in size, CCT and luminous flux.

## Outline Dimension(unit:mm/in)

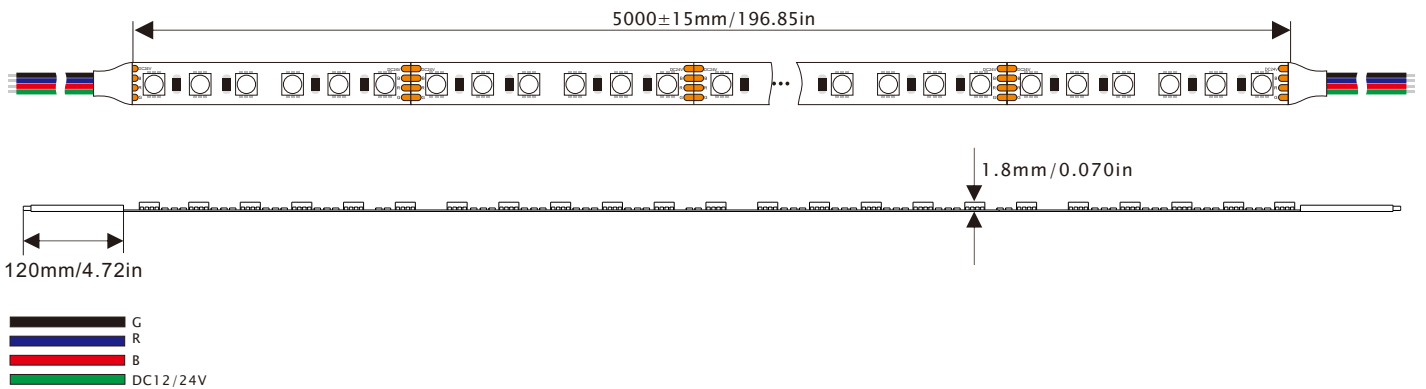
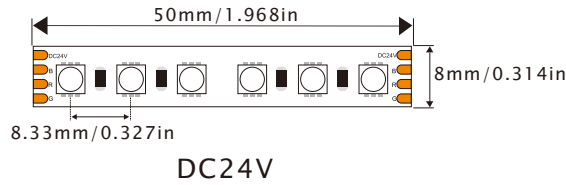
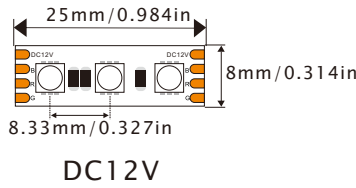

## Wiring diagram

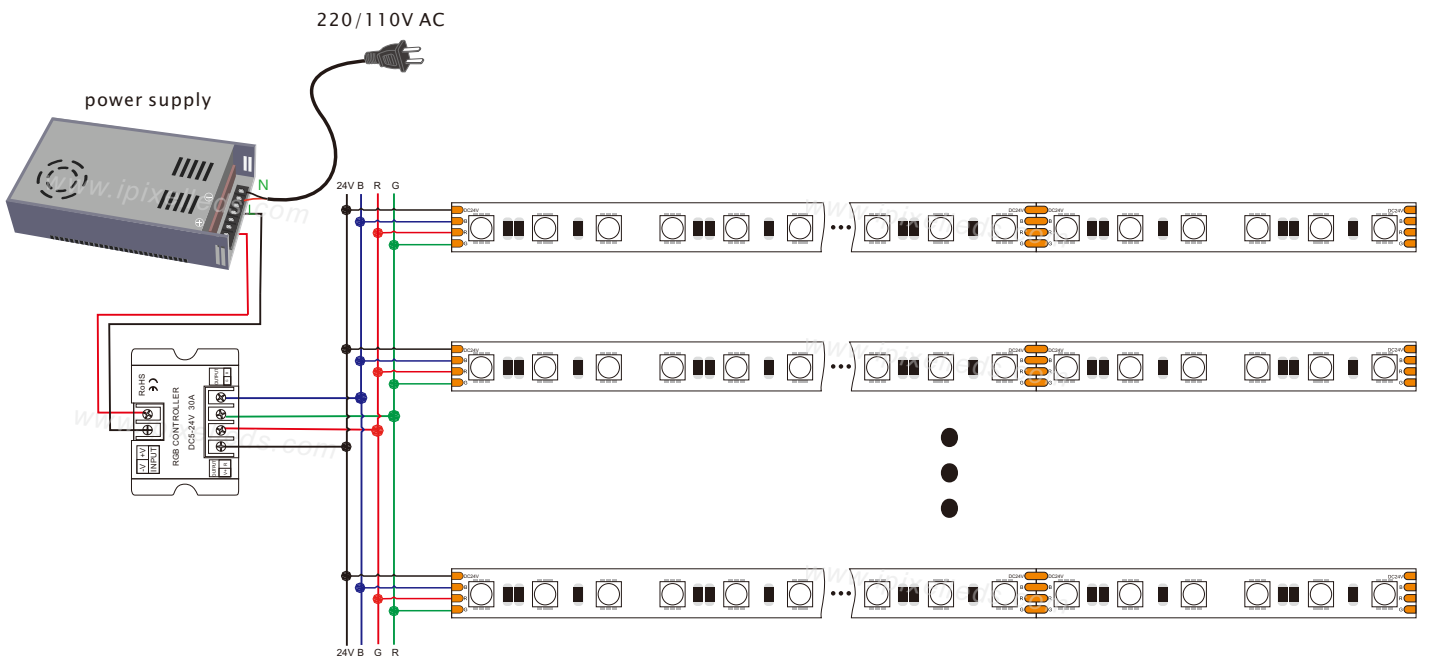

## IP Rating

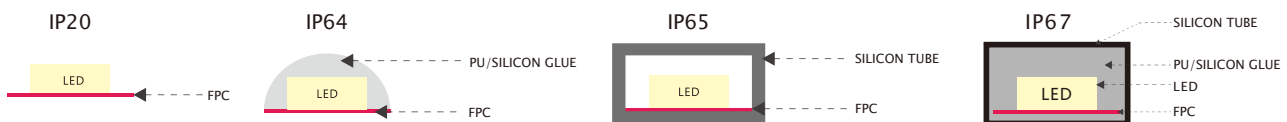

### ◆ Related products:



Power supply  
LRS-350-12  
LRS-350-24

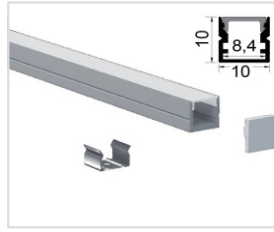

Alum profile  
LL1010



dimmer  
XS-86-03

### ◆ Installation method:

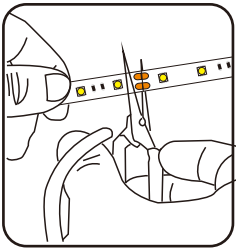

Can be cut

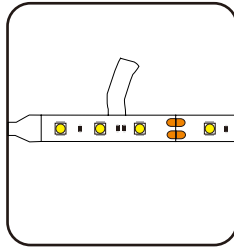

Don't peel all 3M tape at once.

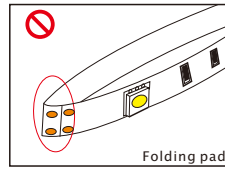

Folding pads

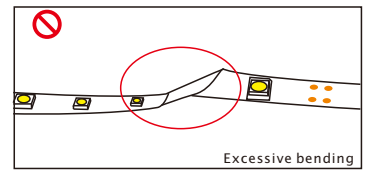

Excessive bending

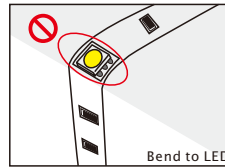

Bend to LED

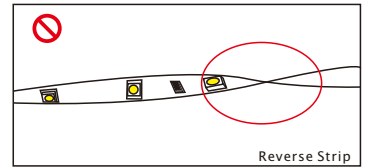

Reverse Strip

Distortion(Wrong)

### ◆ Product packaging



Reel

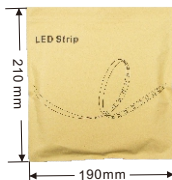

Antistatic bag

